

PLEION
SMART SOLAR SYSTEMS

FREE GO

FREE HOT WATER FROM THE SUN

ONLY
18 KG

**HOT WATER IN 2 CLICKS...
WHEREVER YOU WANT**

DESIGNED AND MANUFACTURED IN ITALY

www.pleion-group.com



DESIGNED AND MANUFACTURED IN ITALY

WATCH THE VIDEO
FreeGO



Hot Water in 2 clicks... wherever you want!

The world's most compact Solar Water Heater,
the only one that can be installed on your own!



**ONLY
18 KG**

**QUICK
COUPLINGS**



**REGULATION OF THE
TEMPERATURE**

All the **PLEION EGO** family's innovations
in a portable format.

In 130 cm **FreeGO** can generate up to 100 litres of hot water
and is feather-weight at only 18 kg!

**Just connect it to a tap and that's all, the sun will start heating
the water and the water temperature is adjustable with
an integrated thermostatic mixer (38°C - 60°C).**



www.pleion-group.com



Founded by the European Union

This project has received funding from the European Union's
Horizon 2020 research and innovation programme under grant
agreement No **882316**

DESIGNED AND MANUFACTURED IN ITALY

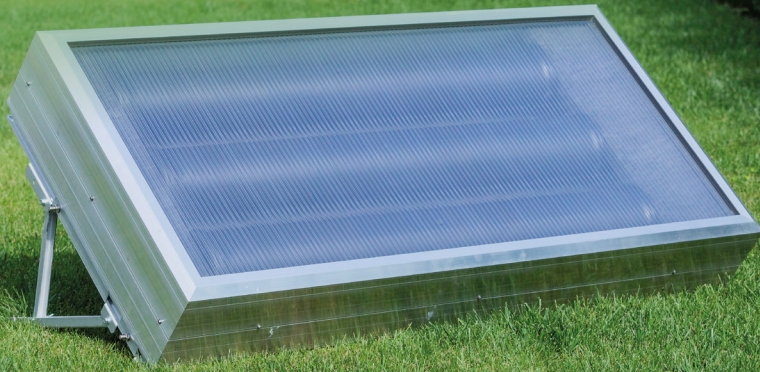

The perfect companion for your leisure time.

With the functionality and simplicity at the first place, *FreeGO* is always with you and provides you with hot water, may it be at home in the garden, on the top of a mountain or on the most remote beaches.

A unique design, the compactness and the easy way to be transported make it perfect for trips, but also for your everyday life and your hobbies, always and everywhere.

DO-IT-YOURSELF installation in just a few seconds!



FREE GO

FREE HOT WATER FROM THE SUN



COURTESY KAERCHER



COURTESY INTEX



1. Place it wherever you want

FreeGO is the world's most compact and lightest (only 18 kg) solar water heater that can be installed where you need it, on your own and in just a few seconds

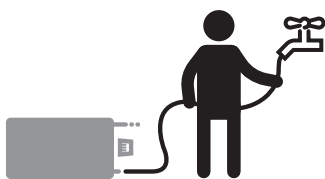

2. Connect it to a tap

FreeGO is equipped with quick couplings that allow you to connect it in 2 clicks to the water supply you have available.



3. Adjust the temperature

As soon as you have connected your *FreeGO* just adjust the desired outlet temperature and use the hot water that is produced by the sun.

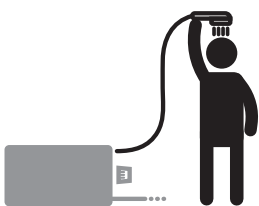

4. Enjoy the Free Hot Water produced by the Sun!

INTEGRATED PLUMBING

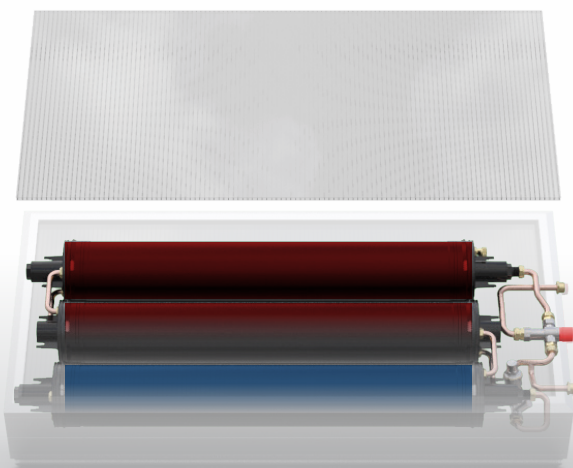
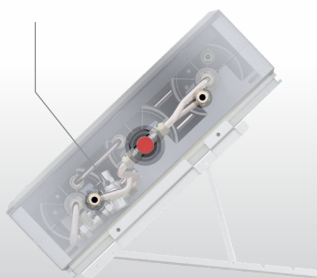

QUICK COUPLINGS
IN BRASS

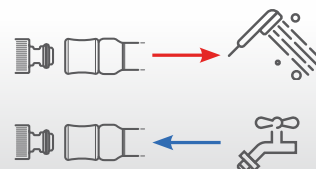



UNBREAKABLE FRONT COVER!

CELLULAR POLYCARBONATE LEXAN® THERMOCLEAR™:

UNBREAKABLE: 250 times more resistant than glass.

LIGHT-WEIGHT: 80% lighter than glass.

TRANSPARENCY: exceptional capacity to conduct the solar radiations and guaranteeing 10 years against yellowing (PATENTED).

PERFORMANCE: significant reduction of heat losses during the night.

DOUBLE UV PROTECTION.

THERMOSTATIC REGULATION OF THE TEMPERATURE.

The integrated mixing system ensures the perfect comfort of the hot water's outlet temperature. With **FREEGO** you can obtain up to 9 minutes of continuously flowing hot water for 8 showers

THE WORLD'S MOST COMPACT AND LIGHTEST (18 KG) SOLAR WATER HEATER!

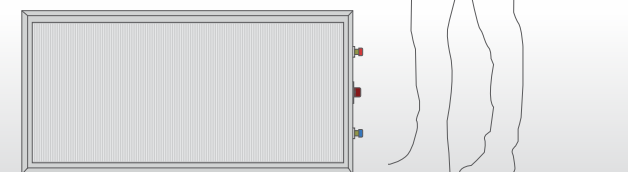

TECHNICAL SPECIFICATIONS

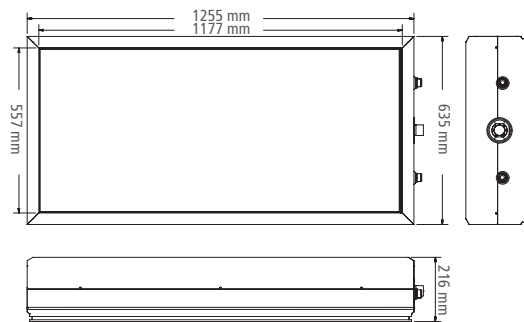

FREEGO

COMPACT AND HIGH EFFICIENT DO-IT-YOURSELF SOLAR THERMAL SYSTEM FOR THE PRODUCTION OF DOMESTIC HOT WATER.

- Dimensions **1255 x 635 x 216 mm**
- Total surface area of the collector **0,80 m²**
- Aperture area of the collector **0,66 m²**
- Absorption area **0,50 m²**
- Capacity **55 lt**
- Empty weight **18 kg**
- Weight when fully loaded **75 kg**
- Inclinations **45°/40°/35°**
- Water temperature at the outlet **38÷60°C**
Adjustable with Thermostatic mixing valve with knob
- Maximum operating temperature **100°C**
- Operating pressure **3 bar**
- Connections **Quick coupling 1/2" GAS F**

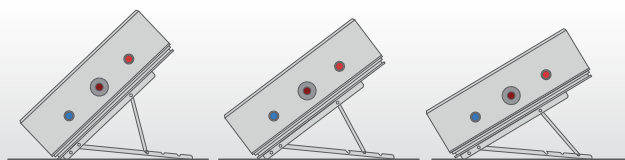

Brackets with adjustable inclination
45°/40°/35°

WATCH THE VIDEO
FREEGO



PLEION
SMART SOLAR SYSTEMS

PLEION Srl
Via Venezia, 11 - Cerea Verona
infoline +39 0442 320295
info@pleion.it

Seguici su



www.pleion-group.com